

DID YOU KNOW?

about our... **Self Drilling Vertical Hangers**



**NEW
PRODUCT**

Self Drilling Right Angle Threaded Rod Hanger - **Metal**

VERTICAL SIDE HANGER METAL ZINC PLATE

Part	QFind	Rod Size	Screw Thread	Length	Overall Length	AF	Pack
		D (Ø)	G-TPI	L1 (mm)	L (mm)	(mm)	Qty
MVMMSZSM06025	MVM104	M6	14g - 20	25	46	16	100
MVMMSZSM08025	MVM105	M8	14g - 20	25	46	16	100
MVMMSZSM10025	MVM106	M10	14g - 20	25	46	16	100



Right Angle Hangers are a one-piece, self drilling fastening system suitable for installation into steel substrates. Ideal for the suspension of threaded rod.

» Application

Suspension of threaded rod for:

- Pipe hanging
- Fire protection
- Electrical conduit and cable-tray
- Recommended thickness of steel 1.0 - 3.0mm

Best installed with cordless impact drivers

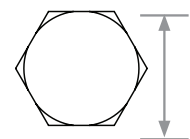
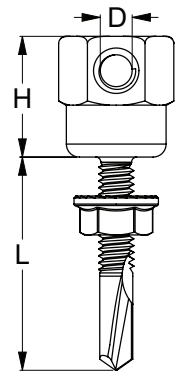
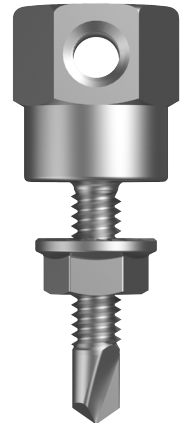

**AF =
16mm**

► Socket to suit: **MXSVS-SI**

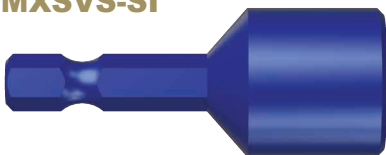

» Features

- Easy and fast installation and attachment
- 1/4" drive
- Socket for easy installation of timber/metal vertical hangers

The supplied backing nut should be used to ensure secure installation

CONX[®]TRUCT

hobson.com.au **QUALITY FASTENERS SINCE 1935**



2103291DYK

DID YOU KNOW?

about our... **Self Drilling Vertical Hangers**



CONSTRUCT

**NEW
PRODUCT**

Self Drilling Vertical Threaded Rod Hanger - **Metal**

VERTICAL HANGER METAL ZINC PLATE

Part	QFind	Rod Size D (Ø)	Screw Thread G-TPI	Thread Length L1 (mm)	Overall Length L (mm)	AF (mm)	Pack Qty
MVMMSZIM100025	MVM103	M10	14g - 20	25	46	16	100



Vertical Hangers are a one-piece, self drilling fastening system suitable for installation into steel substrates. Ideal for the suspension of threaded rod.

» Application

Suspension of threaded rod for:

- Pipe hanging
- Fire protection
- Electrical conduit and cable-tray
- Recommended thickness of steel 1.0 - 3.0mm

Best installed with cordless impact drivers

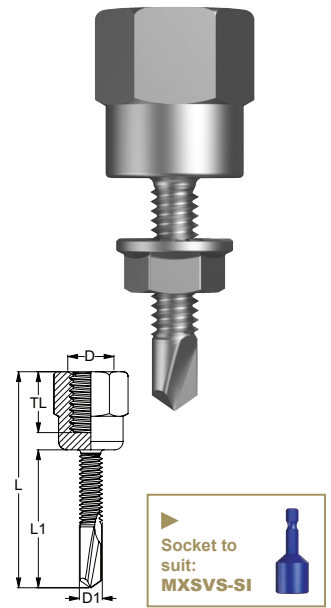

The supplied backing nut should be used to ensure secure installation

Self Drilling Vertical Threaded Rod Hanger T17 - **Timber**

VERTICAL HANGER T17 TIMBER ZINC PLATE

Part	QFind	Rod Size D (Ø)	Screw Thread G-TPI	Thread Length L1 (mm)	Overall Length L (mm)	AF (mm)	Pack Qty
MVWMSZIM100025	MVW102	M10	14g - 10	25	46	16	100

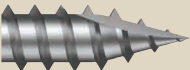

Vertical Hangers are a one-piece, self drilling fastening system suitable for installation into timber. Ideal for the suspension of threaded rod.

» Application

Suspension of threaded rod for:

- Pipe hanging
- Fire protection
- Electrical conduit and cable-tray
- Self drilling into wood / timber beams or joists

Best installed with cordless impact drivers

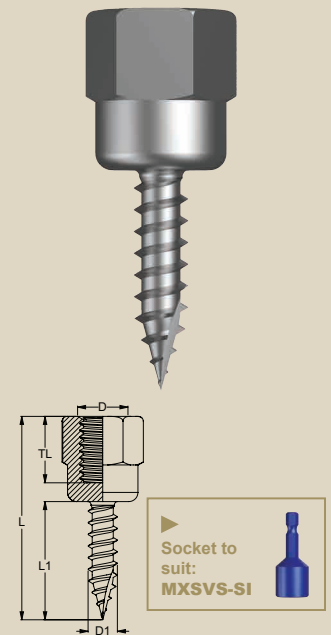

2103291DYK